

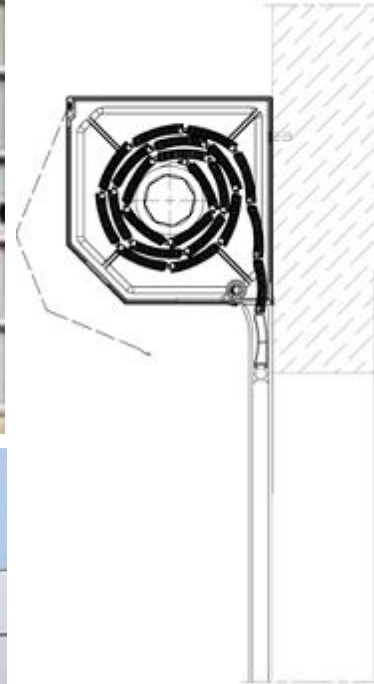

ROLO VRATA CJENOVNIK ZA 2021 GODINU



EURO-ROAL doo
Sarajevska 17,
74 203 Doboj Jug
tel 032-692-518
info@euroroal.ba

EURO-ROAL doo
Garovci bb
Hadžići
tel 033-420-499
info1@euroroal.ba

EURO-ROAL doo
Ostrožac bb
Cazin
tel 037-518-219
hase.h@euroroal.ba

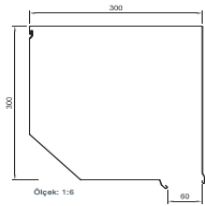

KUTIJA ROLO 300 NATUROLL ASAS

SIFRA ART	BOJA	DUZINA	CIJENA PO METRU
32075/32076	BIJELA	L-6000	36.60 KM
32026/32025	SIVA	L-6000	36.60 KM
32177/32178	BRAON	L-6000	36.60 KM

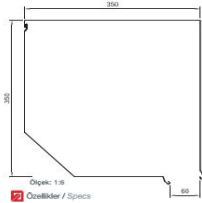

KUTIJA ROLO 350 NATUROLL ASAS

SIFRA ART	BOJA	DUZINA	
32114/32091	BIJELA	L-6000	
32028/32027	SIVA	L-6000	
32169/32170	BRAON	L-6000	



SIFRA ART.	DEKLO 300 AS
32078	BIJELA
32029	SIVA
32181	BRAON



SIFRA ART.	DEKLO 350 AS
32142	BIJELA
32029	SIVA
32173	BRAON



SIFRA ART.	NAZIV ARTIKLA
32185	DISTANCER 300mm

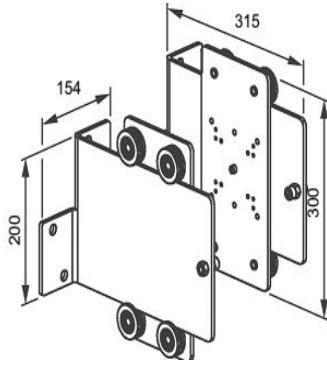

SIFRA ART.	NAZIV ARTIKLA
38054	KONZOLA ZA OSOVINU



SIFRA ART.	NAZIV ARTIKLA
32041	UVODNIK SA TOCKICIMA AS

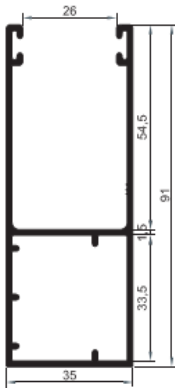

ROLO KANAL ZA VOĐENJE AS		
SIFRA ART.	BOJA	DUŽINA
32033	BIJELA	L-6000
32034	SIVA	L-6000
32171	BRAON	L-6000

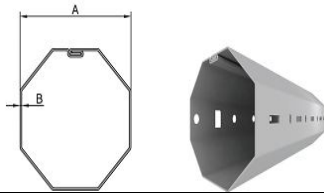

SIFRA ART.	NAZIV ARTIKLA
32038	OKTAGONALNA CIJEV F170 AS
32037	OKTAGONALNA CIJEV F160 AS

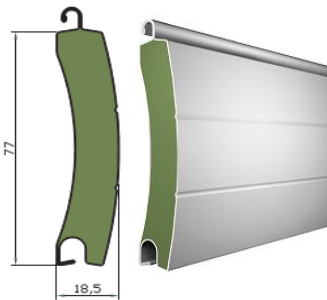

SIFRA ART.	NAZIV ARTIKLA
	LAMELA H77MM AS
38082	LAMELA H77MM ANTRACIT APF

NAPOMENA:

LAMELE H 77 AS TRI BOJE NA LAGERU ;BIJELA SIVA I BRAON

DUŽINE LAMELA H77 AS SU :4000,5000,6500 mm

LAMELA H77MM ANTRACIT APF

DUŽINE SU :5500,6000,7000mm

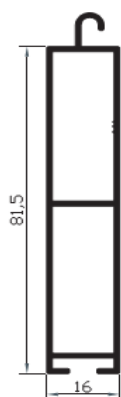

ROLO GRANIČNI PROFLI AS			
SIFRA ART.	BOJA	DUZINA	
32039	BIJELA	L-6000	
32040	SIVA	L-6000	
32172	BRAON	L-6000	
32284	ANTRACIT	L-6000	



SIFRA ART.	NAZIV ARTIKLA
32043	GUMA GRANIC.PR. AS

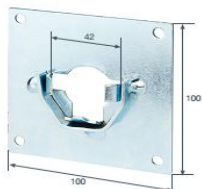

SIFRA ART.	NAZIV ARTIKLA
32047	100X100 PLOCA ZA LEZAJ AS



SIFRA ART.	NAZIV ARTIKLA
32048	LEZAJ 42mm AS

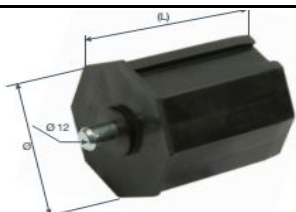

SIFRA ART.	NAZIV ARTIKLA
32049	OKTAG.POKLOPAC FI70 AS
32084	OKTAG.POKLOPAC FI60 AS



SIFRA ART.	NAZIV ARTIKLA
32050	KONEKTOR LAMELE AS



SIFRA ART.	NAZIV ARTIKLA
32055	KON.LAM SA SIG.BRAVOM AS

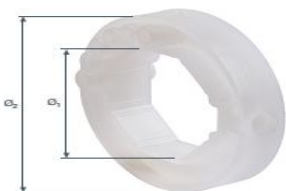

SIFRA ART.	NAZIV ARTIKLA
32085	PRSTEN ZA OSOVINU FI60 AS
32056	PRSTEN ZA OSOVINU FI70 AS



SIFRA ART.	NAZIV ARTIKLA
32045	PVC CEP ZA LAM.77MM AS



SIFRA ART.	NAZIV ARTIKLA
32255	KURBLA KUKA AS



SIFRA ART.	NAZIV ARTIKLA
32193	KURBLA BEZ CIJEVI AS BIJ.



SIFRA ART.	NAZIV ARTIKLA
32192	CIJEV ZA KURBLU 1600 AS

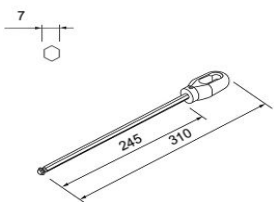

SIFRA ART.	NAZIV ARTIKLA
33552	NAST. ZA KURBLU GEV/APF

DM59M-120/9

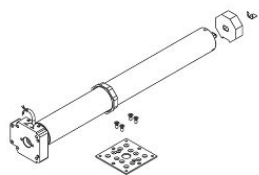

SIFRA ART.	NAZIV ARTIKLA
38103	MOTOR FI70/120NmAPF

KARKATERISTIKE MOTORA 120/Nm

Toegepassing met as Utilisé avec un axe Angewendet mit Welle Applied with reel	SW 70, AW 125
Totale lengte buismotor Longueur total du moteur Gesamtlänge des Antriebs The total length of the motor	667 mm
Aantal omwentelingen / Werkingstijd Nombre de tours / Temps du travail Anzahl der Umdrehungen / Betriebszeit Number of turns / Working time	9 min ⁻¹ / 4 min
Koppeling / Nominale stroom drijfwerk Couple / Courant admissible Drehmoment / Nennstrom des Antriebs Torque / Motor rated current	120 Nm / 1,56 A
Vermogensverbruik / Voedingsspanning / Frequentie Consommation électrique / Tension d'alimentation / fréquence Kraftaufnahme / Versorgungsspannung / Frequenz Power consumption / Power supply / Frequency	350 kW / 230 V AC / 50 Hz
Beschermingsgraad Degré de protection Sicherungsgrad Protection rating	IP 44



SIFRA ART.	NAZIV ARTIKLA
32064	RESIVER ZA MOTOR AS



SIFRA ART.	NAZIV ARTIKLA
32065	DALJINSKI AS



SIFRA ART.	NAZIV ARTIKLA
38510	PREKIDAC M



SIFRA ART.	NAZIV ARTIKLA
50969	GARAZNI PLAFONSKI MOTOR

KOMPONENTE ROLO VRATA

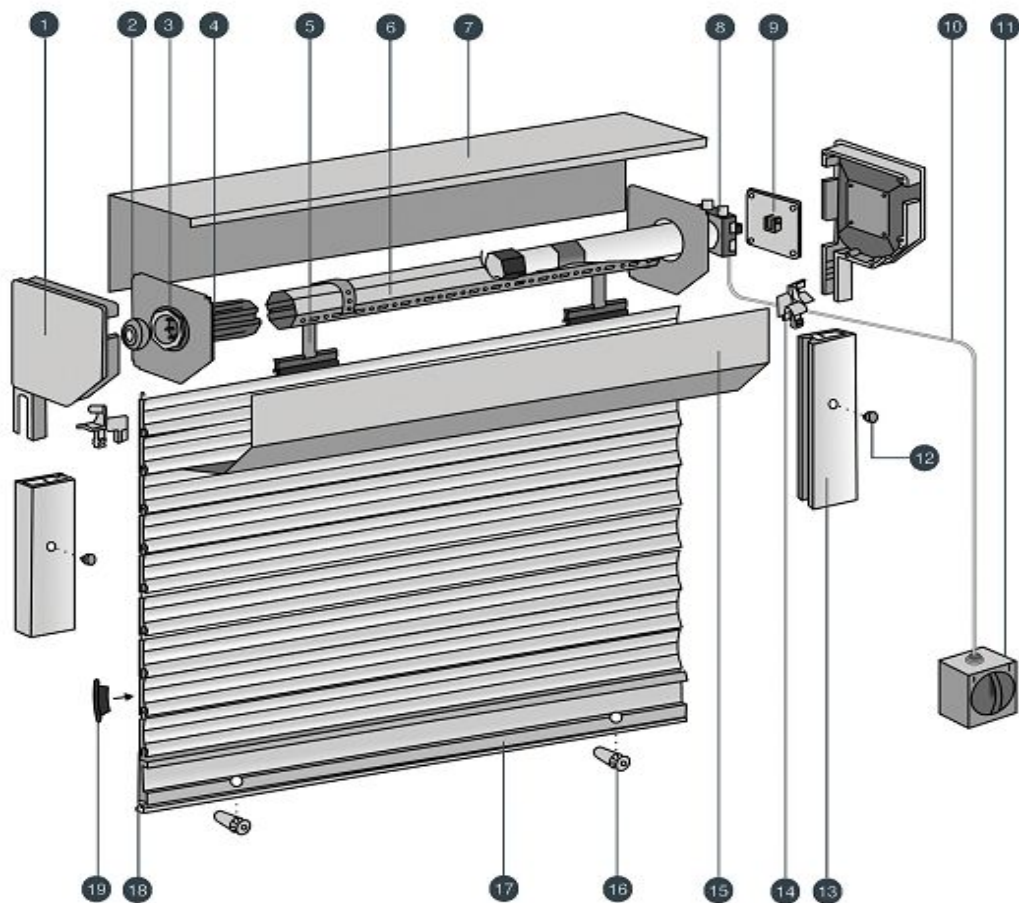

- | | |
|------------------------|----------------------------|
| 1-Deklo kutije | 11-Prekidač |
| 2-Ležaj | 12-Čep fi 10 |
| 3-Distnacer | 13-Kanal za vođenje |
| 4-Oktogonalni poklopac | 14-Uvodnik s točkićima |
| 5-Konketor lamele | 15-Prednji dio kutije |
| 6-Oktogonalna cijev | 16-Vanjski stoper |
| 7-Zadnji dio kutije | 17-Granični profil |
| 8-Motor | 18-Guma za granični profil |
| 9-Ploča 100x100 | 19-Poklopac lamele |
| 10-Napon struje | |
-