

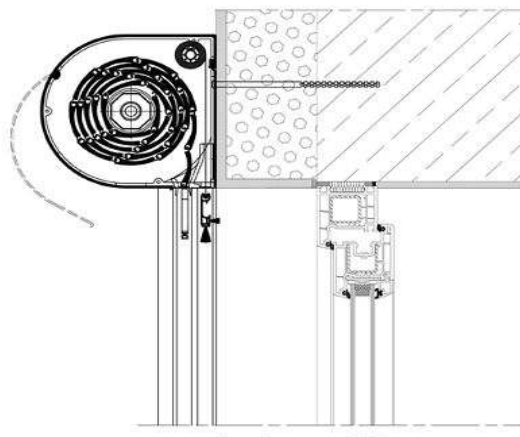

ROLETNA CJENOVNIK ZA 2021 GODINU

**ASAS**



EURO-ROAL doo  
Sarajevska 17,  
74 203 Doboj Jug  
tel 032-692-518  
info@euroroal.ba

EURO-ROAL doo  
Garovci bb  
Hadžići  
tel 033-420-499  
info1@euroroal.ba

EURO-ROAL doo  
Ostrožac bb  
Cazin  
tel 037-518-219  
hase.h@euroroal.ba

# ASAS

## ROLETNA CJENOVNIK ZA 2020 GODINU

### KUTIJA VANJSKA 45 STEPENI 137 ASAS

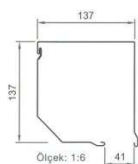

SIFRA ART	BOJA	DUZINA
32007/32010	BIJELA	L-6000
32009/32012	SIVA	L-6000
32008/32011	BRAON	L-6000
32068/32069	ZLATNI H	L-6000

### KUTIJA VANJSKA 45 STEPENI 165 ASAS

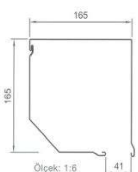

SIFRA ART	BOJA	DUZINA
32013/32016	BIJELA	L-6000
32015/32018	SIVA	L-6000
32014/32017	BRAON	L-6000
32113/32112	ZLATNI H	L-6000



SIFRA ART	DEKLO 137/165 ASAS
	<b>BOJA</b>
32139	BIJELA
32140	SIVA
32216	BRAON

### KUTIJA VANJSKA RUND 150 ASAS

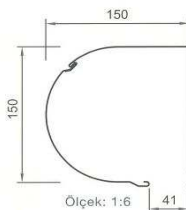

SIFRA ART	BOJA	DUZINA
32197/32198	BIJELA	L-6000
32199/32220	SIVA	L-6000
32204/32205	BRAON	L-6000

### KUTIJA VANJSKA RUND 180 ASAS

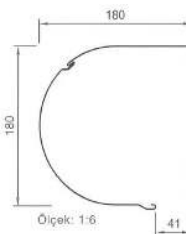

SIFRA ART	BOJA	DUZINA
32200/32201	BIJELA	L-6000
32206/32207	SIVA	L-6000
32202/32203	BRAON	L-6000



<b>SIFRA ART</b>	DEKLO RUND 150/180 ASAS
	<b>BOJA</b>
<b>32211</b>	BIJELA
<b>32212</b>	SIVA
<b>32213</b>	BRAON



<b>SIFRA ART</b>	OPIS
<b>32092</b>	SIGURNOSNI LIM 137 ASAS
<b>32093</b>	SIGURNOSNI LIM 165 ASAS



<b>SIFRA ART</b>	OPIS
<b>32217</b>	SIGURNOSNI LIM 150 RUND ASAS
<b>32218</b>	SIGURNOSNI LIM 180 RUND ASAS



<b>SIFRA ART</b>	OPIS
<b>32044</b>	PVC VOĐICA ASAS

**MAXIMALNA VISINA S KUTIJOM(mm)**

KUTIJA	BEZ KOM.	SA KOM.
137	1560	
150	2040	1250
165	2430	
180	3260	2440

VODILICE ZA ROLETNU JEDNODJELNE

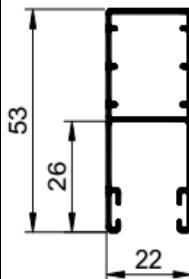

SIFRA ART	BOJA	DUZINA
12101	BIJELA	L-6000
12100	SIVA	L-6000
12102	BRAON	L-6000
11658	ZLATNI HR.	L-6000
12104	ANTRACIT	L-6000

VODILICE DVODJELNE ZA ROLETNU I KOMARNIK

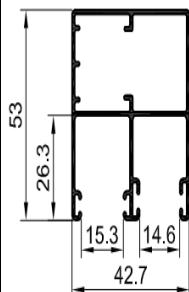

SIFRA ART	BOJA	DUZINA
38025	BIJELA	L-6000
38024	SIVA	L-6000
38049	BRAON	L-6000
38193	RAL 8019	L-6000
38070	ANTRACIT	L-6000
38105	ZLATNI HR	L-6000

VODILICE DVODJELNE ZA ROLETNU (H-VODILICA)

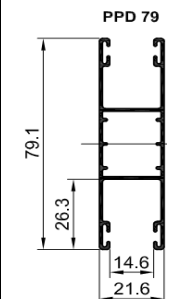

SIFRA ART	BOJA	DUZINA
38178	BIJELA	L-6000
38030	SIVA	L-6000
38031	BRAON	L-6000
38180	RAL 8019	L-6000
38179	ANTRACIT	L-6000
	ZLATNI HR	L-6000

GRANIČNI PROFIL ZA LAMELU (POČETNA)



SIFRA ART	BOJA	DUZINA
38035	BIJELA	L-6000
38000	SIVA	L-6000
38036	BRAON	L-6000
38176	RAL 8019	L-6000
38064	ANTRACIT	L-6000
38123	ZLATNI HR	L-6000

GRANIČNI PROFIL ZAKOMARNIK INTEGRISANI ALUPROF (POČETNA)

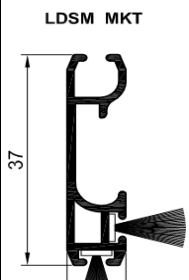

SIFRA ART	BOJA	DUZINA
38020	BIJELA	L-6000
38019	SIVA	L-6000
38052	BRAON	L-6000
38196	RAL 8019	L-6000
38130	ANTRACIT	L-6000
38112	ZLATNI HR	L-6000

ALUMINIJSKA LAMELA H39 ALUPROF

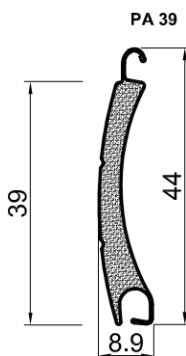

SIFRA ART	BOJA	DUZINA
38035	BIJELA	L6500
38000	SIVA	L6500
38036	BRAON	L6500
38176	RAL 8019	L6500
38064	ANTRACIT	L6500
38123	ZLATNI HR	L6500
38053	MAHAGONI	L6500

ALUMINIJSKA LAMELA H39 AS

32000	BIJELA	L6500
32001	SIVA	L6500
32002	BRAON	L6500
32317	ANTRACIT	L6500
32070	ZLATNI HR	L6500

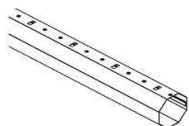

SIFRA ART	OPIS
10212	OKTAGONALNA CIJEV FI 40

RNS MKT



SIFRA ART	OPIS
38021	MREZA ZA INTEG.ROLO KOMARNIK 1600X6000 APF
38022	MREZA ZA INTEG.ROLO KOMARNIK 2500X6000 APF



Stupac1	Stupac2
Težina 1m2=2,8 kg	
Debljina= 9mm	
Broj lamela na 1m visine=25,6kom	
Max površina=6m2	
Visina profila=39mm	



SIFRA ART	OPIS
50114	ČETKICA 67X60



SIFRA ART	OPIS
50896	GUMA ZA GRANIČNI PROFIL



SIFRA ART	OPIS
50254	POKLOPAC LAMELE H39

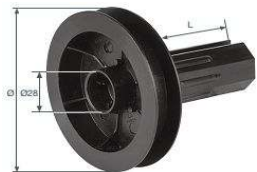

SIFRA ART	OPIS
50490	KOTUR 120
50491	KOTUR 140



SIFRA ART	OPIS
50492	OKTAGON POKLOPAC PVC 40mm LOF

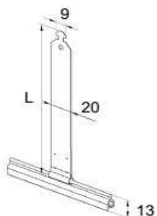

SIFRA ART	OPIS
50159	KONEKTOR LAMELE SA PLASTIKOM

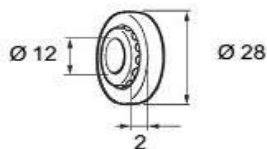

SIFRA ART	OPIS
10285	LEŽAJ



SIFRA ART	OPIS
50428	VANJSKI STOPER SVE BOJE



SIFRA ART	OPIS
50386	SKRIVENI STOPER



SIFRA ART	OPIS
10273	KOČNICA BEZ ZAKLJUČAVANJA



SIFRA ART	OPIS
33500	MAGACIN TRAKA SVE BOJE
33504	MAGACIN ŠPAGA SVE BOJE



SIFRA ART	OPIS
50327	ULAZ ZA TRAKU SVE BOJE

## DM35S-10/17

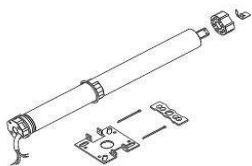

<b>SIFRA ART</b>	OPIS
<b>38097</b>	MOTOR ZA ROLETNU

Toegepassing met as   Utilisé avec un axe   Angewendet mit Welle   Applied with reel	SW 40
Totale lengte buismotor   Longueur total du moteur   Gesamtlänge des Antriebs   The total length of the motor	473 mm
Aantal omwentelingen / Werkingsijd   Nombre de tours / Temps du travail   Anzahl der Umdrehungen / Betriebszeit   Number of turns / Working time	17 min <sup>2</sup> / 4 min
Koppeling / Nominale stroom drijfwerk   Couple / Courant admissible   Drehmoment / Nennstrom des Antriebs   Torque / Motor rated current	10 Nm / 0,53 A
Vermogensverbruik / Voedingsspanning / Frequentie   Consommation électrique / Tension d'alimentation / fréquence   Kraftaufnahme / Versorgungsspannung / Frequenz   Power consumption / Power supply / Frequency	121 kW / 230 V AC / 50 Hz
Beschermingsgraad   Degrée de protection   Sicherungsgrad   Protection rating	IP 44

## DC115A



<b>SIFRA ART</b>	OPIS
<b>38101</b>	DALJINSKI 1 KANALA APF

## DC50

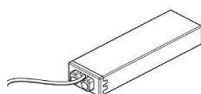

<b>SIFRA ART</b>	OPIS
<b>38090</b>	RESIVER ZA MOTOR DM35S/17

## DC313

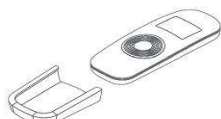

<b>SIFRA ART</b>	OPIS
<b>38099</b>	DALJINSKI 15 KANALA APF

## DC306



<b>SIFRA ART</b>	OPIS
<b>38098</b>	DALJINSKI 5 KANALA APF



<b>SIFRA ART</b>	OPIS
<b>38202</b>	SIGURNOSNI KONEKTOR APF



<b>SIFRA ART</b>	OPIS
<b>38203</b>	PRSTEN ZA SIG. KONEKTOR



Maks. kapacite  
Max. capacity

13 kg

SIFRA ART	OPIS
32095	REDUKOTOR



SIFRA ART	OPIS
32097	NASTAVAK ZA KURBLU



SIFRA ART	OPIS
32157	UMETAK ZA KURBLU AS



SIFRA ART	OPIS
32193	KURBLA BEZ CIJEVI AS BIJELA



SIFRA ART	OPIS
32192	CIJEV ZA KURBLU 1600 AS



SIFRA ART	OPIS
32096	POKLOPAC ZA REDUKTOR AS



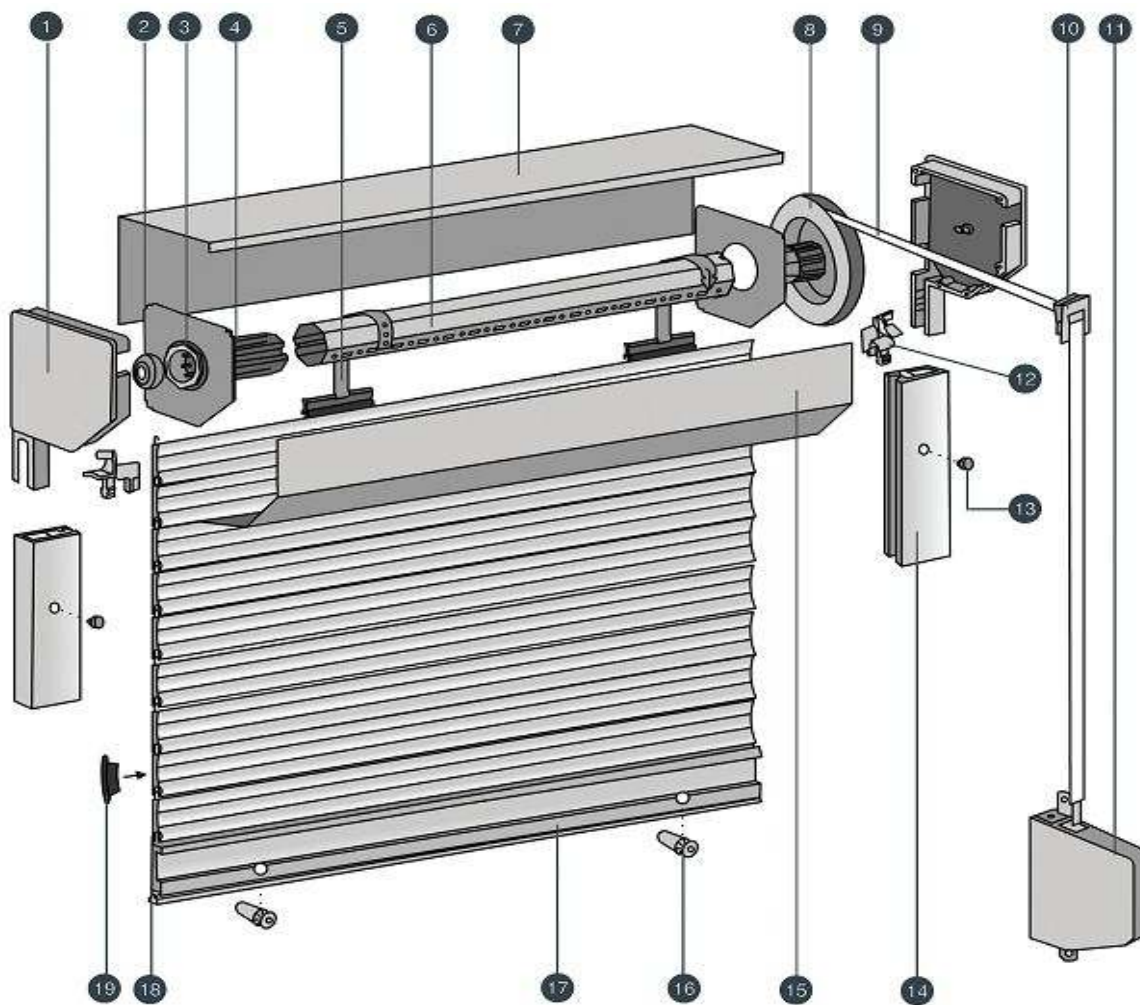

- |                        |                            |
|------------------------|----------------------------|
| 1-Deklo kutije         | 11-Magacin s trakom        |
| 2-Ležaj                | 12-Pvc vođica              |
| 3-Distnacer            | 13-Čep fi 10               |
| 4-Oktogonalni poklopac | 14-Kanal za vođenje        |
| 5-Konketor lamele      | 15-Prednji dio kutije      |
| 6-Oktogonalna cijev    | 16-Vanjski stoper          |
| 7-Zadnji dio kutije    | 17-Granični profil         |
| 8-Kotur za traku       | 18-Guma za granični profil |
| 9-Traka                | 19-Poklopac lamele         |
| 10-Ulaz za traku       |                            |

EURO-ROAL doo  
Sarajevska 17,  
74 203 Doboj Jug  
tel 032-692-518  
[info@euroroal.ba](mailto:info@euroroal.ba)

EURO-ROAL doo  
Garovci bb  
Hadžići  
tel 033-420-499  
[info1@euroroal.ba](mailto:info1@euroroal.ba)

EURO-ROAL doo  
Ostrožac bb  
Cazin  
tel 037-518-219  
[hase.h@euroroal.ba](mailto:hase.h@euroroal.ba)